

5.6. TM-040 + TM-090

n_1 [1/min]	n_2 [1/min]	i	i_1	i_2	η_d	P_1 [kW]	M_N [Nm]	P_s [kW]	M_2 [Nm]	f
1400	4,67	300	20	15	0,49	0,50	500	0,37	370	1,35
	3,50	400	20	20	0,46	0,38	480	0,37	460	1,03
	2,80	500	25	20	0,44	0,32	480	0,25	380	1,28
	2,33	600	20	30	0,38	0,35	550	0,25	390	1,41
	1,87	750	25	30	0,37	0,29	550	0,25	470	1,16
	1,56	900	30	30	0,34	0,26	550	0,25	520	1,05
	1,17	1200	40	30	0,32	0,21	550	0,18	470	1,17
	0,93	1500	50	30	0,3	0,18	550	0,18	550	1,00
	0,78	1800	60	30	0,28	0,15	500	0,12	410	1,21
	0,58	2400	60	40	0,26	0,12	500	0,12	510	0,98
	0,44	3200	80	40	0,23	0,10	500	0,09	450	1,11
	0,35	4000	80	50	0,21	0,08	470	0,06	340	1,37
	0,29	4800	80	60	0,2	0,06	420	0,06	390	1,07

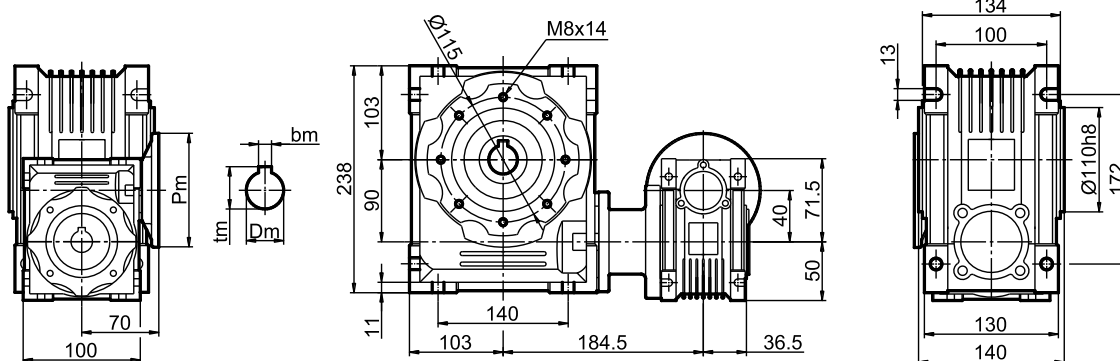

kołnierz silnikowy				
silnik	Pm	Dm	bm	tm
56B5	120	9	3	10,4
63B14	90	11	4	12,8
63B5	140	11	4	12,8
71B14	105	14	5	16,3
71B5	160	14	5	16,3

Ramię reakcyjne

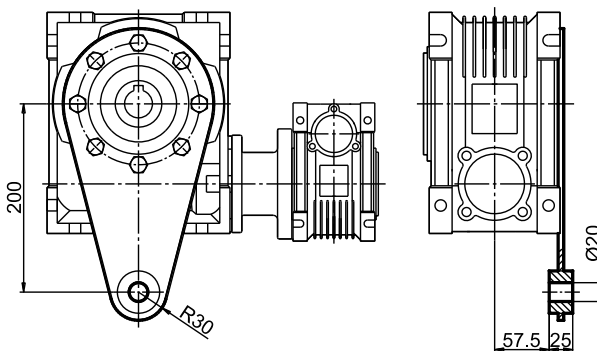

Kołnierz mocowania

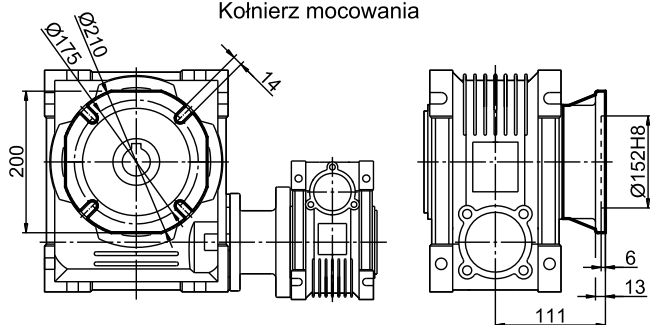

Wał zdawczy jednostronny

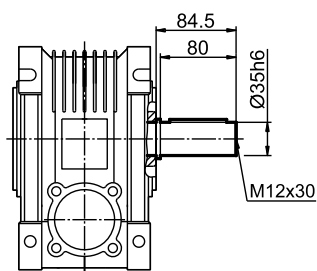

Wał zdawczy dwustronny

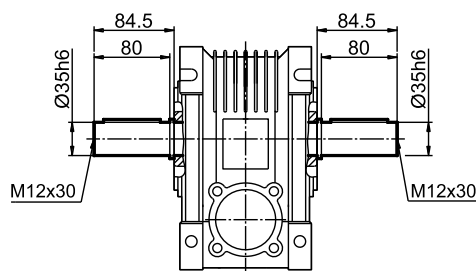

Tuleja zdawcza

